

Data Sheet

Product: 7500 LTS Concrete Tank

DIMENSIONS / VOLUMES / WEIGHT

Measure	Unit	
Total height*	(cm)	265
Entry height*	(cm)	237
Exit height*	(cm)	235
Length	(cm)	238
Width	(cm)	158
Total volume	(m ³)	6.60
Useful volume	(m ³)	6.10
Weight	(T)	3.30
Manhole	(cm)	1 x Ø60
Ø IN / OUT	(mm)	110/110

* tolerance ± 2 cm

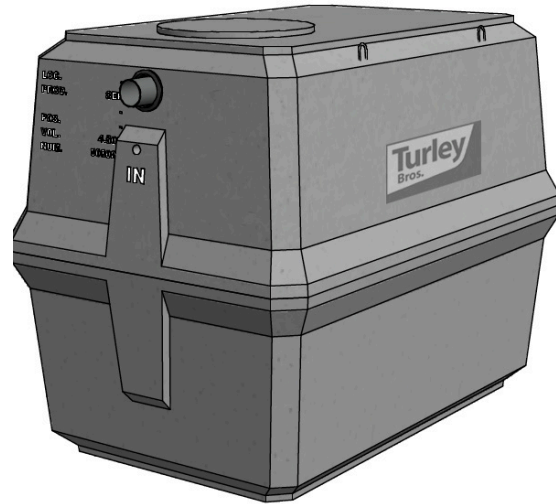

Material

Tank(s) High performance fibre reinforced concrete

OPERATION

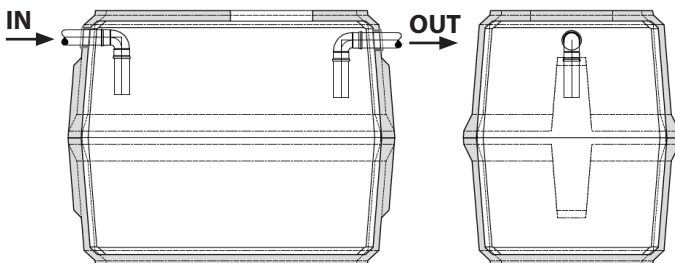

SIZING

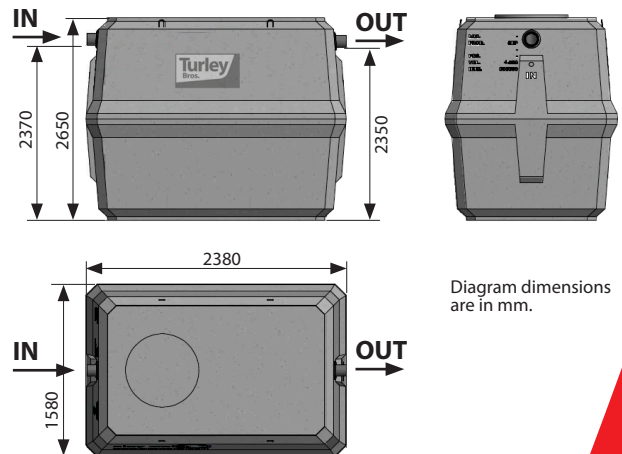

GUARANTEES

Tank : 10 years
Resistance B125

Turley Bros reserves the right to modify, or more generally, to update this document at any time without prior notice.